

# GEOMETRIJSKA TIJELA I PLOHE

## KUGLA

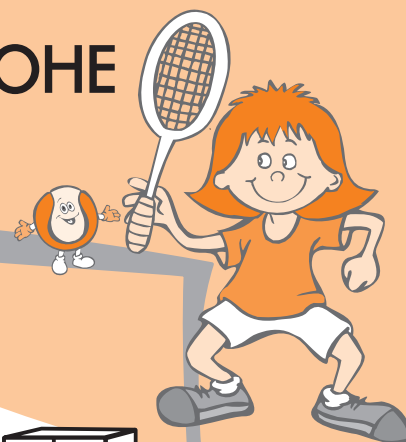

PREKRIŽI SVE ŠTO IMA OBLIK LOPTE.



PREKRIŽI KUGLE.

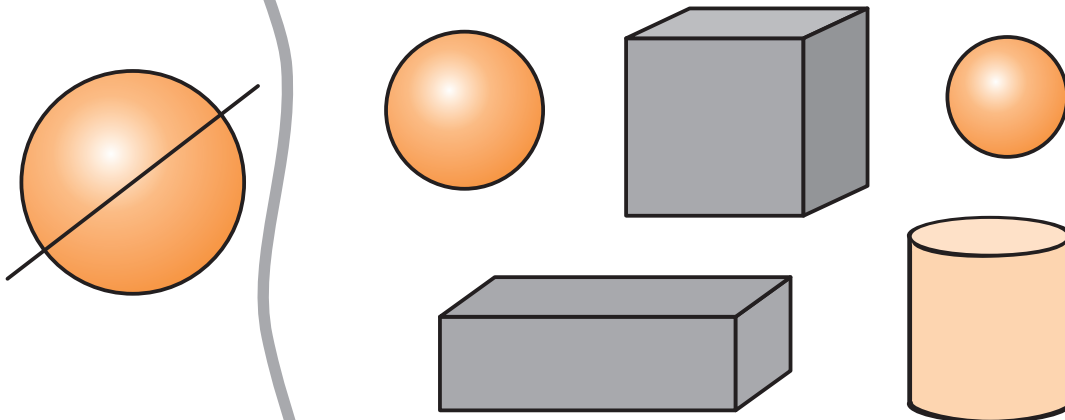

OBOJI KUGLE.

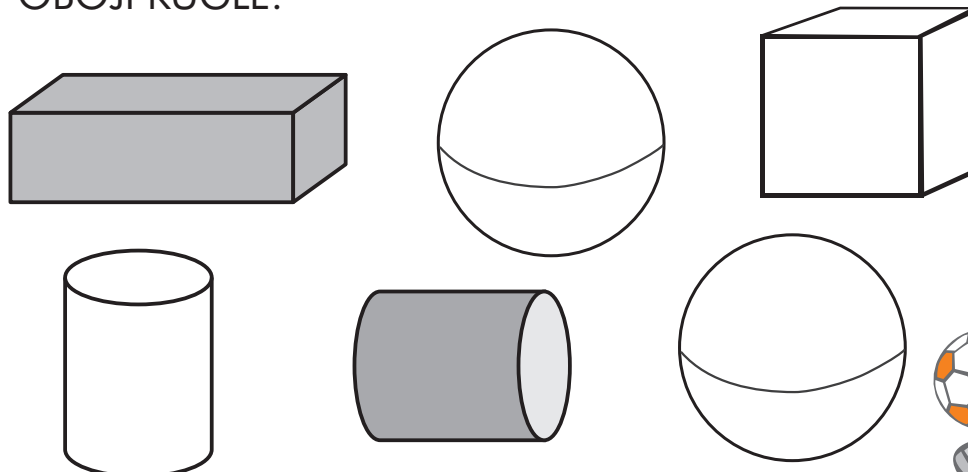



PREKRIŽI GEOMETRIJSKA TIJELA KOJA NISU KUGLE.

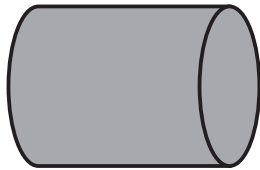
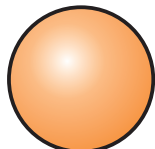
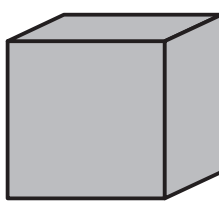
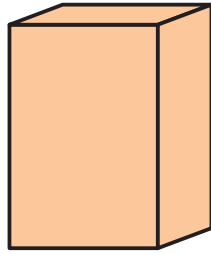
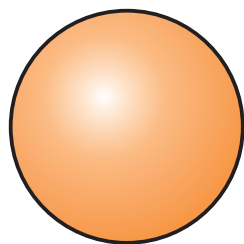
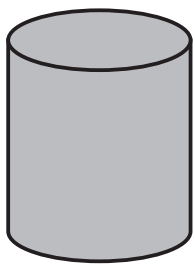
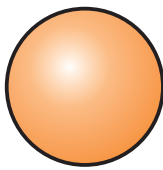

OBOJI GEOMETRIJSKA TIJELA KOJA NISU KUGLE.

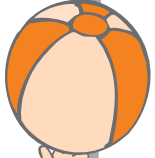
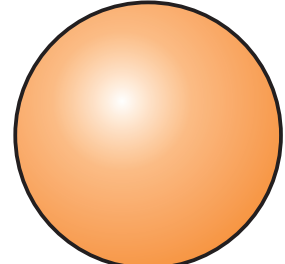
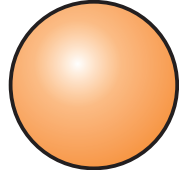
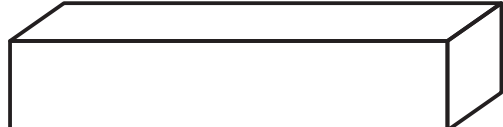
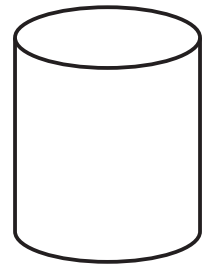
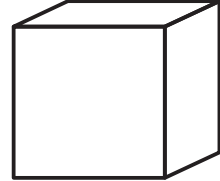
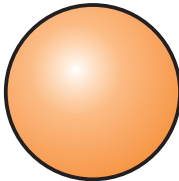

# KOCKA



PREKRIŽI SVE ŠTO JE OBLIKA KOCKE.

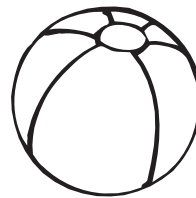
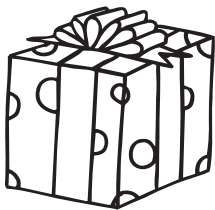
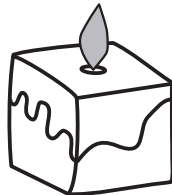
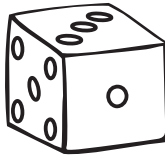

OBOJI KOCKE.

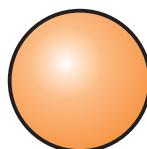
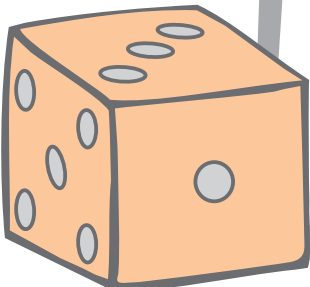
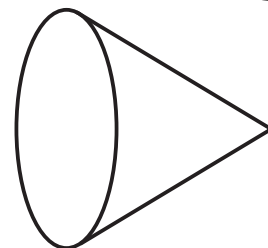
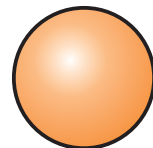
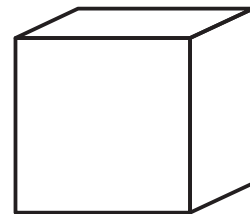
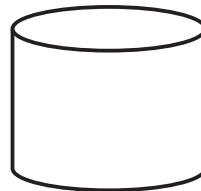
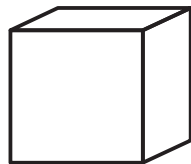



OBOJI KOCKE.

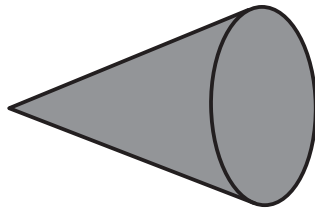
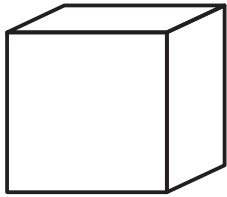
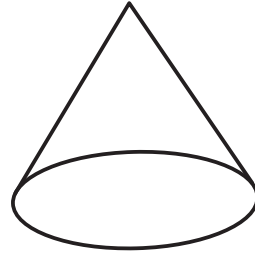
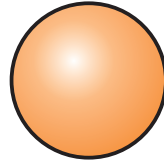
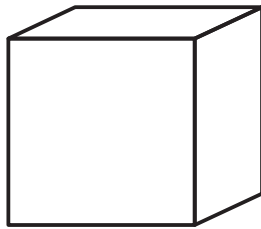
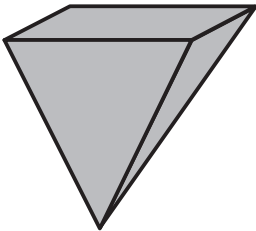

OBOJI GEOMETRIJSKA TIJELA KOJA NISU KOCKE.

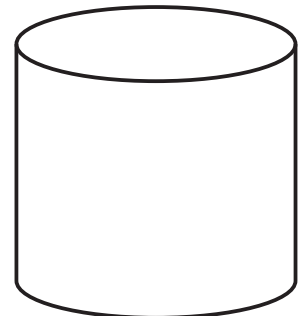
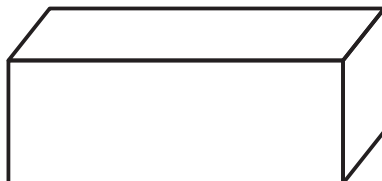
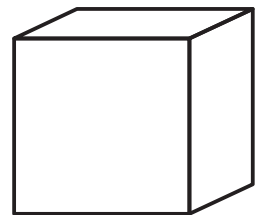
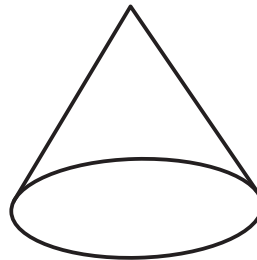
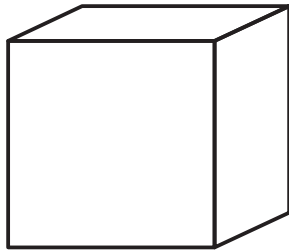

# VALJAK

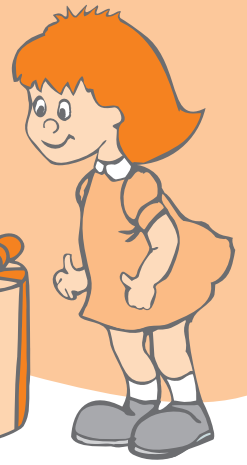

PREKRIŽI SVE ŠTO JE OBLIKA VALJKA.

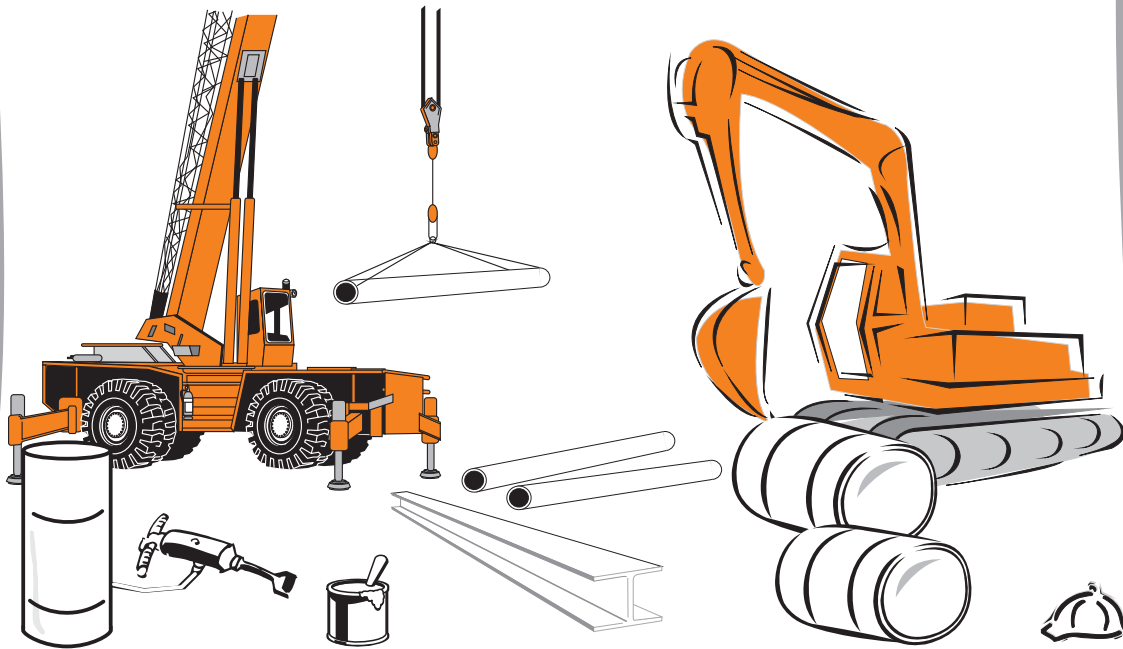

OBOJI VALJKE.

